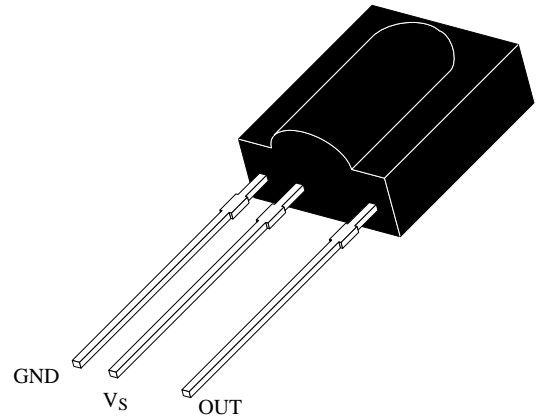

Photo Modules for PCM Remote Control Systems

Available types for different carrier frequencies

Type	f ₀	Type	f ₀
TFMS 5300	30 kHz	TFMS 5330	33 kHz
TFMS 5360	36 kHz	TFMS 5370	36.7 kHz
TFMS 5380	38 kHz	TFMS 5400	40 kHz
TFMS 5560	56 kHz		



94 8691

Description

The TFMS 5..0 – series are miniaturized receivers for infrared remote control systems. PIN diode and preamplifier are assembled on lead frame, the epoxy package is designed as IR filter.

The demodulated output signal can directly be decoded by a microprocessor. The main benefit is the reliable function even in disturbed ambient and the protection against uncontrolled output pulses.

Features

- Photo detector and preamplifier in one package
- Output active low (active high modules: TFMS 5..9)
- Internal filter for PCM frequency
- High immunity against ambient light
- Improved shielding against electric field disturbance
- 5 Volt supply voltage, low power consumption
- TTL and CMOS compatibility
- Continuous transmission possible ($t_{pi}/T \leq 0.4$)

Block Diagram

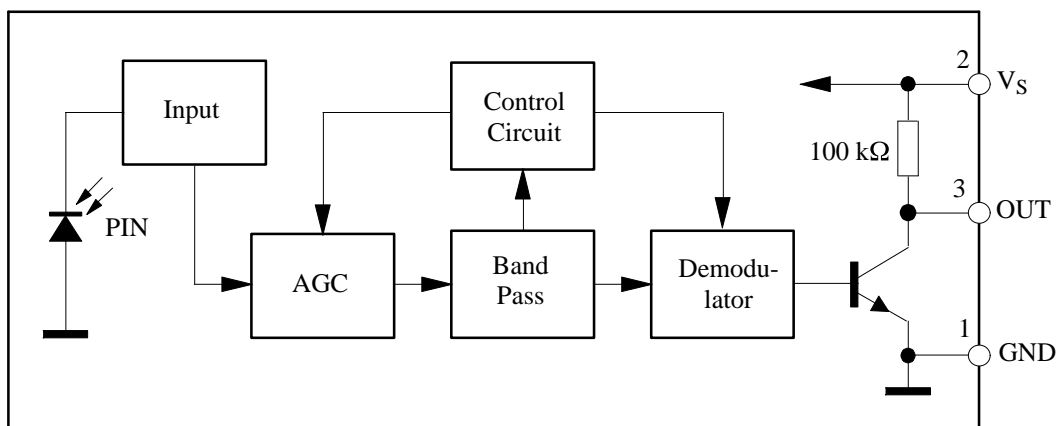

94 8136

Absolute Maximum Ratings

$T_{amb} = 25^{\circ}\text{C}$

Parameter	Test Conditions	Symbol	Value	Unit
Supply Voltage	(Pin 2)	V_S	-0.3...6.0	V
Supply Current	(Pin 2)	I_S	5	mA
Output Voltage	(Pin 3)	V_O	-0.3...6.0	V
Output Current	(Pin 3)	I_O	5	mA
Junction Temperature		T_j	100	$^{\circ}\text{C}$
Storage Temperature Range		T_{stg}	-25...+85	$^{\circ}\text{C}$
Operating Temperature Range		T_{amb}	-25...+85	$^{\circ}\text{C}$
Power Consumption	($T_{amb} \leq 85^{\circ}\text{C}$)	P_{tot}	50	mW
Soldering Temperature	$t \leq 10\text{ s}$, 1 mm from case	T_{sd}	260	$^{\circ}\text{C}$

Basic Characteristics

$T_{amb} = 25^{\circ}\text{C}$

Parameter	Test Conditions	Symbol	Min	Typ	Max	Unit
Supply Current (Pin 2)	$V_S = 5\text{ V}$, $E_v = 0$	I_{SD}	0.4	0.5	0.8	mA
	$V_S = 5\text{ V}$, $E_v = 40\text{ klx}$, sunlight	I_{SH}		1.0		mA
Transmission Distance	$E_v = 0$, test signal see fig.7, IR diode TSIP5201, $I_F = 1.5\text{ A}$	d		35		m
Output Voltage Low (Pin 3)	$I_{OSL} = 0.5\text{ mA}$, $E_e = 0.7\text{ mW/m}^2$, $f = f_o$, $t_p/T = 0.4$	V_{OSL}			250	mV
Irradiance (30 – 40 kHz)	Pulse width tolerance: $t_{po} = t_{pi} \pm 160\mu\text{s}$, test signal (see fig.7)	$E_e\text{ min}$		0.3	0.5	mW/m^2
Irradiance (56 kHz)	Pulse width tolerance: $t_{po} = t_{pi} \pm 160\mu\text{s}$, test signal (see fig.7)	$E_e\text{ min}$		0.4	0.7	mW/m^2
Irradiance		$E_e\text{ max}$	20			W/m^2
Directivity	Angle of half transmission distance	$\phi_{1/2}$		± 55		deg

Application Circuit

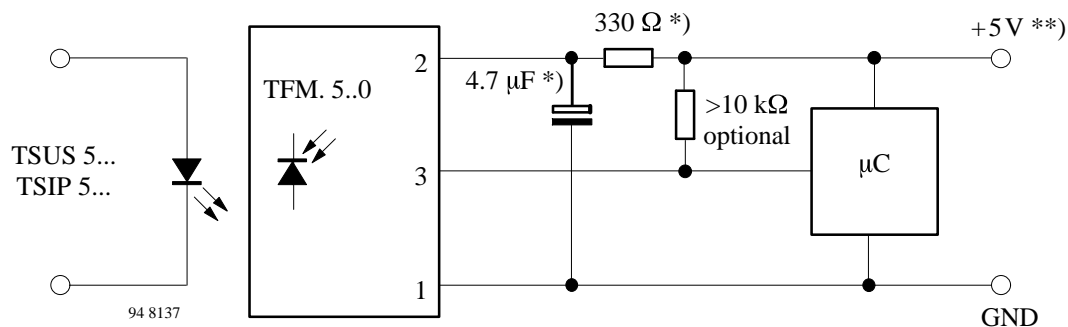

*) only necessary to suppress power supply disturbances

***) tolerated supply voltage range : $4.5\text{ V} < V_S < 5.5\text{ V}$

Typical Characteristics ($T_{amb} = 25^{\circ}\text{C}$ unless otherwise specified)

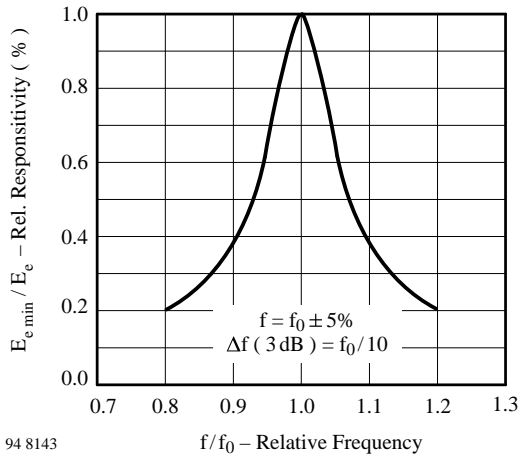

94 8143

Figure 1. Frequency Dependence of Responsivity

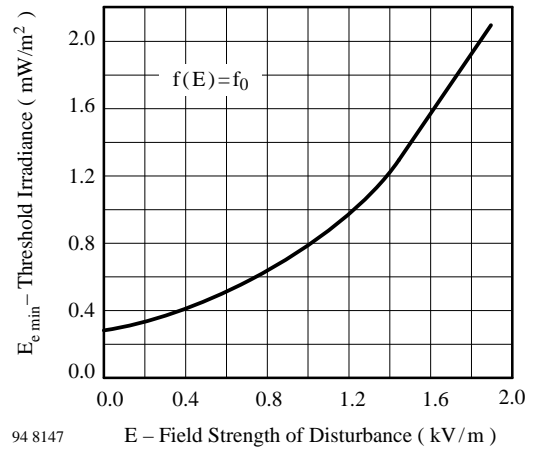

94 8147

Figure 4. Sensitivity vs. Electric Field Disturbances

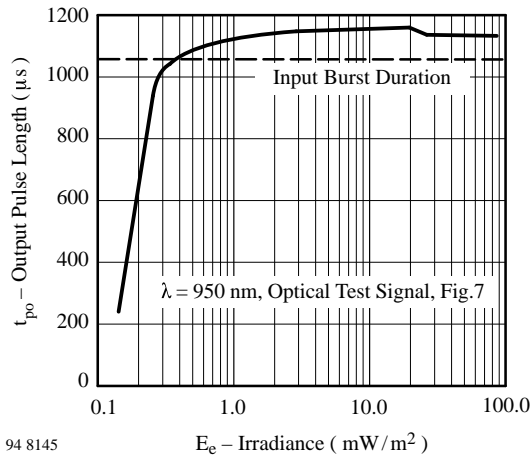

94 8145

Figure 2. Sensitivity in Dark Ambient

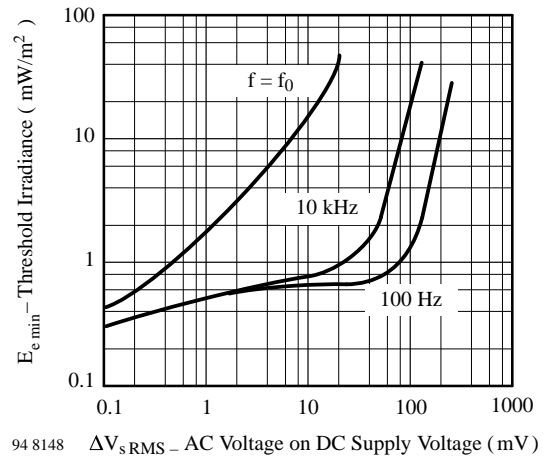

94 8148

Figure 5. Sensitivity vs. Supply Voltage Disturbances

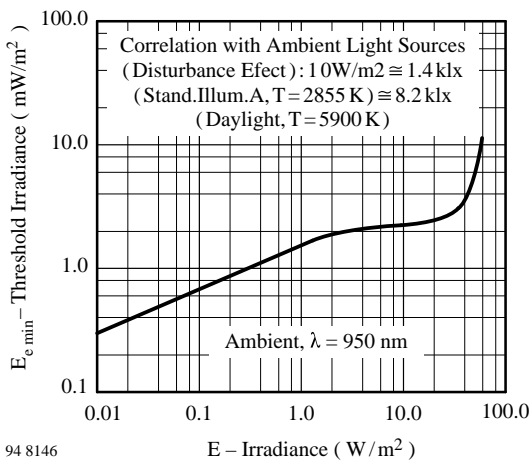

94 8146

Figure 3. Sensitivity in Bright Ambient

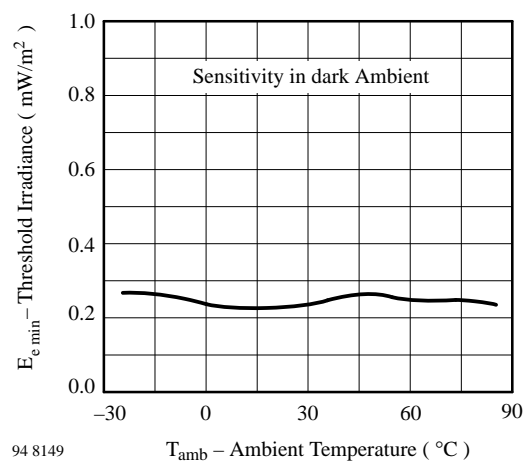

94 8149

Figure 6. Sensitivity vs. Ambient Temperature

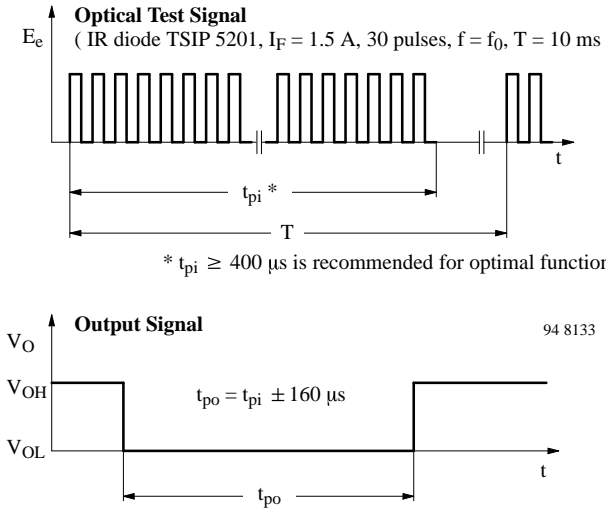

Figure 7. Output Function

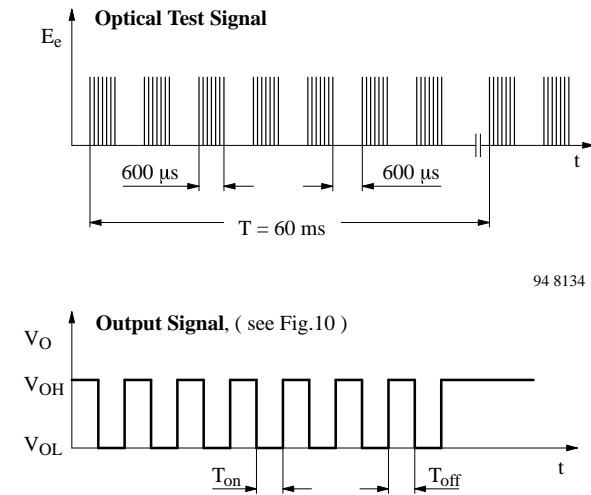

Figure 8. Output Function

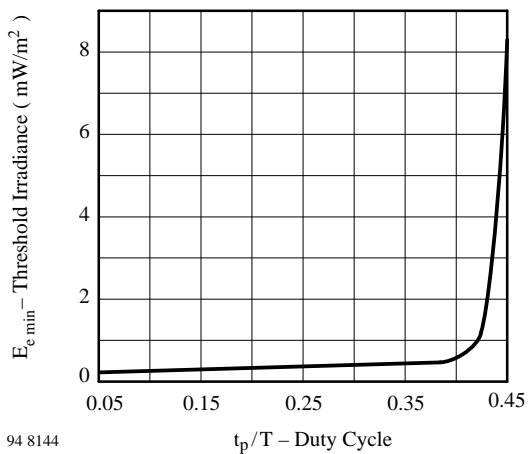

Figure 9. Sensitivity vs. Duty Cycle

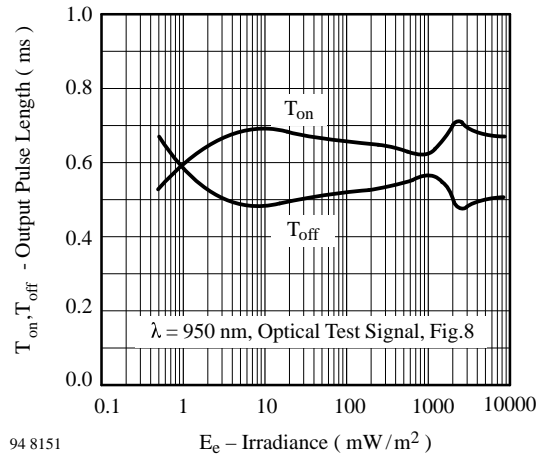

Figure 10. Output Pulse Diagram

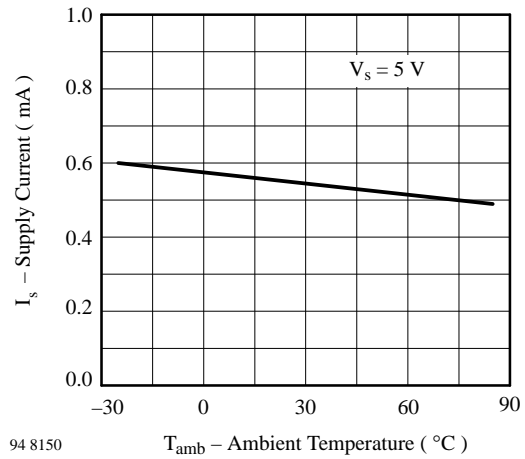

Figure 11. Supply Current vs. Ambient Temperature

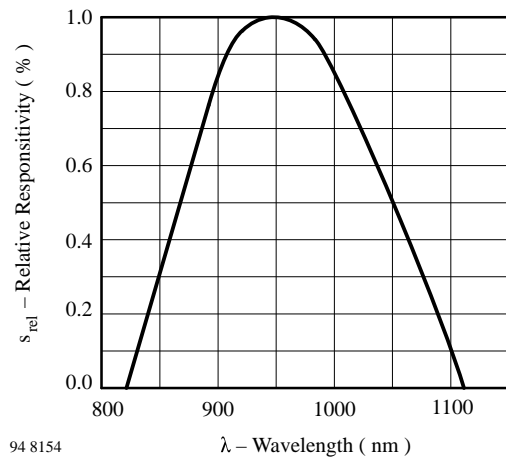

Figure 12. Spectral Response

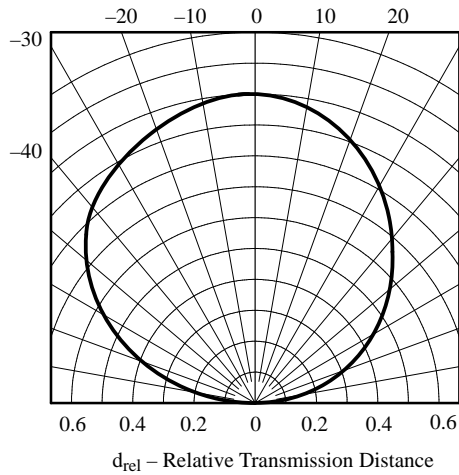

Figure 13. Vertical Directivity ϕ_y

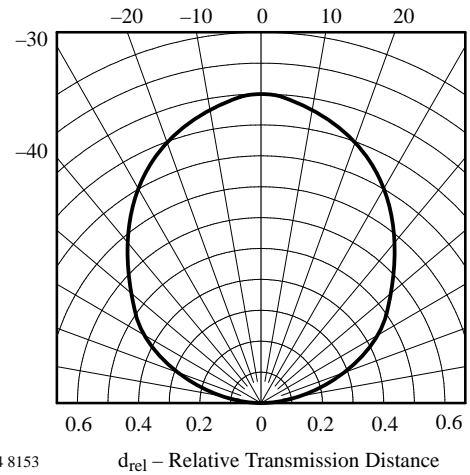
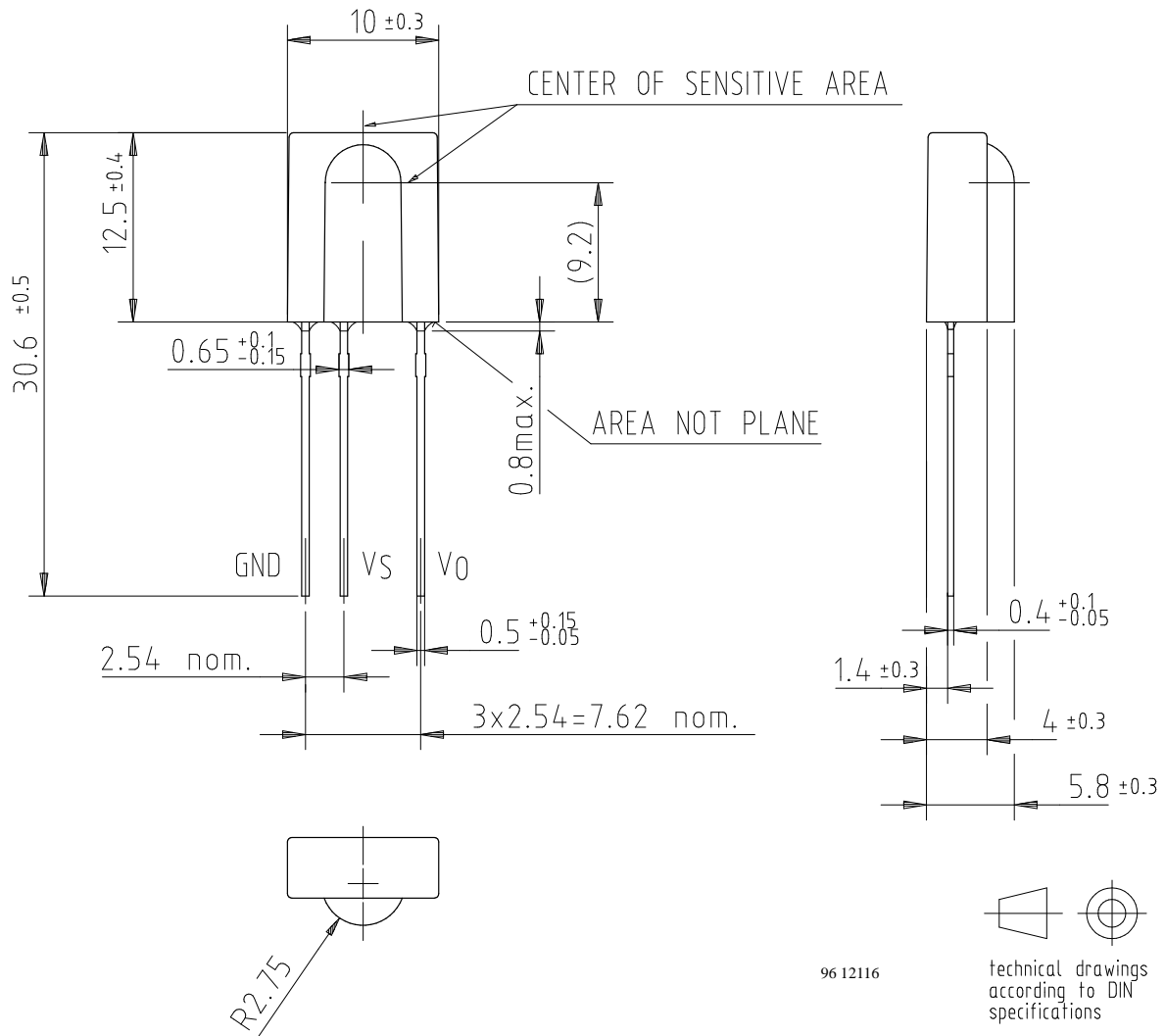

Figure 14. Horizontal Directivity ϕ_x

Dimensions in mm



Ozone Depleting Substances Policy Statement

It is the policy of **TEMIC TELEFUNKEN microelectronic GmbH** to

1. Meet all present and future national and international statutory requirements.
2. Regularly and continuously improve the performance of our products, processes, distribution and operating systems with respect to their impact on the health and safety of our employees and the public, as well as their impact on the environment.

It is particular concern to control or eliminate releases of those substances into the atmosphere which are known as ozone depleting substances (ODSs).

The Montreal Protocol (1987) and its London Amendments (1990) intend to severely restrict the use of ODSs and forbid their use within the next ten years. Various national and international initiatives are pressing for an earlier ban on these substances.

TEMIC TELEFUNKEN microelectronic GmbH semiconductor division has been able to use its policy of continuous improvements to eliminate the use of ODSs listed in the following documents.

1. Annex A, B and list of transitional substances of the Montreal Protocol and the London Amendments respectively
2. Class I and II ozone depleting substances in the Clean Air Act Amendments of 1990 by the Environmental Protection Agency (EPA) in the USA
3. Council Decision 88/540/EEC and 91/690/EEC Annex A, B and C (transitional substances) respectively.

TEMIC can certify that our semiconductors are not manufactured with ozone depleting substances and do not contain such substances.

We reserve the right to make changes to improve technical design and may do so without further notice.

Parameters can vary in different applications. All operating parameters must be validated for each customer application by the customer. Should the buyer use TEMIC products for any unintended or unauthorized application, the buyer shall indemnify TEMIC against all claims, costs, damages, and expenses, arising out of, directly or indirectly, any claim of personal damage, injury or death associated with such unintended or unauthorized use.

TEMIC TELEFUNKEN microelectronic GmbH, P.O.B. 3535, D-74025 Heilbronn, Germany
Telephone: 49 (0)7131 67 2831, Fax number: 49 (0)7131 67 2423